

PosiTector® 6000 Series

Coating Thickness Gages for **ALL** Metal Substrates



NEW! PosiTector App



Mobile app connects PosiTector Advanced instruments to your *iOS* or *Android* smart device.

DeFelsko®
The Measure of Quality



Available on the
App Store



PosiTector®
SmartLink
Compatible



PosiTector® 6000 Series

All Gages Feature...

Simple

- Ready to measure—no adjustment required for most applications
- Enhanced one-handed menu navigation
- Flashing display—ideal in a noisy environment
- RESET feature instantly restores factory settings

Durable

- Solvent, acid, oil, water and dust resistant—weatherproof
- Wear-resistant probe tip
- Shock-absorbing, protective rubber holster with belt clip
- Two year warranty on gage body AND probe

Accurate

- Certificate of Calibration showing traceability to NIST or PTB included
- Built-in temperature compensation ensures measurement accuracy
- Hi-RES mode increases displayed resolution for use on applications that require greater precision
- Conforms to national and international standards including ISO and ASTM

Versatile

- PosiTector body universally accepts all PosiTector 6000, 200, RTR, SPG, DPM and UTG probes easily converting from a coating thickness gage to a surface profile gage, dew point meter or ultrasonic wall thickness gage
- Multiple calibration adjustment options including 1 point, 2 point, known thickness, average zero
- Selectable display languages
- High contrast reversible color LCD with backlit display
- Flip Display enables right-side-up viewing
- Extended cables available (up to 75 m/250 ft) for remote measuring
- Uses alkaline or rechargeable batteries (built-in charger)

Powerful

- Continually displays/updates average, standard deviation, min/max thickness and number of readings while measuring
- Screen Capture—save screen images for record keeping and review
- HiLo alarm audibly and visibly alerts when measurements exceed user-specified limits
- FAST mode—faster measurement speed for quick inspection
- USB port for fast, simple connection to a PC and to supply continuous power. USB cable included.
- PosiSoft USB Drive—stored readings and graphs can be accessed using universal PC/Mac web browsers or file explorers. No software required.
- Every stored measurement is date and time stamped
- Software updates via internet keep your gage current
- Includes PosiSoft suite of software for viewing and reporting data (see right panel)

Probes available for a variety of applications



For measuring paint, powder, etc. on all metals...



...and for measuring galvanizing, plating, anodizing and more.

Standard Models

Includes ALL features as shown on left plus...

- Storage of 250 readings—stored readings can be viewed or downloaded

Advanced Models

Includes ALL features as shown on left plus...

- Storage of 100,000 readings in up to 1,000 batches and sub-batches
- Real time graphing and batch notes
- Batch annotation—add notes and change batch names with onscreen QWERTY keyboard
- Scan mode—take continuous readings without lifting the probe
- Multiple stored calibration adjustments for measuring on a variety of substrate conditions
- SSPC-PA2 feature determines if film thickness over a large area conforms to user-specified min/max levels
- PSPC 90/10 feature determines if a coating system complies with an IMO performance standard for protective coatings
- WiFi technology wirelessly synchronizes with PosiSoft.net and downloads software updates
- Data transfer via USB to a PC or via Bluetooth® Wireless Technology to a mobile device, PC or printer

NEW PosiTector App

- Mobile app connects PosiTector Advanced instruments to your *iOS* or *Android* smart device
- Auto-pairing *Bluetooth BLE* connection
- Easily create custom reports from your measurement data in seconds
- Export readings to PosiSoft Desktop or synchronize readings with PosiSoft.net for further reporting and archival options
- For a complete list of features visit www.defelsko.com/PosiSoft



Select from a variety of measurement ranges and probe styles

(see back page ordering guide)

Heavy-duty, gold-plated locking connector for industrial environments



Cabled Probe Style



Built-in Probe Style

Removable Probes can be detached and replaced with any one of our wide variety of probes including separate probes and microprobes



Thick

90°

0°

45°

Regular

Rugged Features...

Sealed USB Port
for communicating
with a PC or Mac

Water and dust
resistant



High contrast reversible
color LCD with
backlit display

Scratch/solvent/impact
resistant lens

Multi-function
navigation button

Solvent, acid, oil
resistant, high grade,
industrial strength
housing

Advanced Model shown in Memory Mode

Quality high-flex
cable and strain relief

Stainless steel probe
with knurled finger grip

Strong wear-resistant
ruby-tipped probe

All Regular Cabled Probes
are suitable for underwater use

NEW!
Duplex
probe



FNDS Probe measures individual layer thicknesses
of zinc and paint in a duplex coating system



FHXS Probe with Alumina wear face and
braided cable for hot or rough surfaces



Flip Display enables right-side-up viewing



Microprobe series for small parts
and hard-to-reach areas

PosiSoft® ... FREE SOLUTIONS for viewing, analyzing and reporting data:



PosiSoft Desktop

Powerful desktop software for
downloading, viewing, printing
and storing measurement data.
Includes customizable, templated
PDF Report Generator. No internet
connection required.

PosiSoft.net

A web-based application offering secure centralized
management of readings. Includes customizable,
templated PDF Report Generator. Access your
data from any web-connected device.



PosiTector App

Mobile app connects PosiTector
Advanced instruments, the
PosiTector SmartLink and the
PosiTest AT-A to your *iOS* or
Android smart device.



PosiSoft USB Drive

A simple gage interface to retrieve
data in a manner similar to USB
flash drives, cameras, or digital
audio players. No software to
install or internet connection
required.

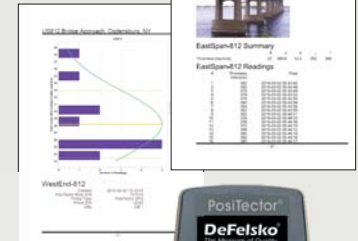

PosiTector bodies
accept all 6000,
200, RTR, SPG, DPM
and UTG probes



PosiTector® 6000 Series		Our most popular Removable Built-in and Regular Cabled probe models			90° Regular probe for tight spots	Ideal for duplex coating systems	Ideal for anodized aluminum	Microprobes – Our smallest probes for small parts or hard-to-reach areas			Removable Built-in and Cabled probes for thick protective coatings; epoxy, rubber, intumescent fireproofing and more							
		ORDERING GUIDE																
FERROUS PROBES	Standard	F1	FS1	FXS1*	FRS1			FOS1	F45S1	F90S1	FT1	FTS1	FHXS1**	FKS1	FLS1			
	Advanced	F3	FS3	FXS3*	FRS3			FOS3	F45S3	F90S3	FT3	FTS3	FHXS3**	FKS3	FLS3			
NON-FERROUS PROBES	Standard	N1	NS1		NRS1		NAS1	NOS1	N45S1	N90S1			NKS1					
	Advanced	N3	NS3		NRS3		NAS3	NOS3	N45S3	N90S3			NKS3					
COMBINATION PROBES	Standard	FN1	FNS1		FNRS1	FNDS1^					FNTS1				FNGS1†			
	Advanced	FN3	FNS3		FNRS3	FNDS3^					FNTS3				FNGS3†			
Range		0–60 mils 0–1500 µm				Ferrous: 0–45 mils and 0–1150 µm Non-Ferrous: 0–25 mils and 0–625 µm				0–250 mils 0–6 mm		0–400 mils 0–10,000 µm		0–500 mils 0–13 mm		0–1.5 inches 0–38 mm		0–2.5 inches 0–63.5 mm
Accuracy‡		±(0.05 mil + 1%) 0-2 mils ±(0.1 mil + 1%) >2 mils ±(1 µm + 1%) 0-50 µm ±(2 µm + 1%) >50 µm				±(0.02 mil + 1%) 0-4 mils ±(0.1 mil + 3%) >4 mils ±(0.05 µm + 1%) 0-100 µm ±(2 µm + 3%) >100 µm				±(0.5 mil + 1%) 0-100 mils ±(0.5 mil + 3%) >100 mils ±(0.01 mm + 1%) 0-2.5 mm ±(0.01 mm + 3%) >2.5 mm		±(0.1 mil + 3%) ±(1 mil + 3%)		±(0.02 mm + 3%) ±(0.2 mm + 3%)		±(0.01 in. + 3%) ±(0.2 mm + 3%)		
Matching DeFelsko Calibration Standards		STDS1 STDA1				STDS2 STDA2				STDP1		STDP7		STDP5		STDP8		STDP8 (included)

Ferrous probes measure non-magnetic coatings on ferrous metals. **Non-Ferrous probes** measure non-conductive coatings on non-ferrous metals. ***FXS Xtreme probe** with Alumina wear face. Ideal for rough surfaces. ****FHXS Xtreme probe** with Alumina wear face and braided cable measures non-conductive coatings on steel. Ideal for rough or hot surfaces up to 250° C (500° F). **^FNDS probes** for full accuracy information see website. **†FNGS probe** measures non-conductive coatings on all metals. ‡Accuracies are stated as a fixed value plus a percentage of the gage's actual reading.

Probe Details

(All probe details can be found online at www.defelsko.com/p6000/probes)

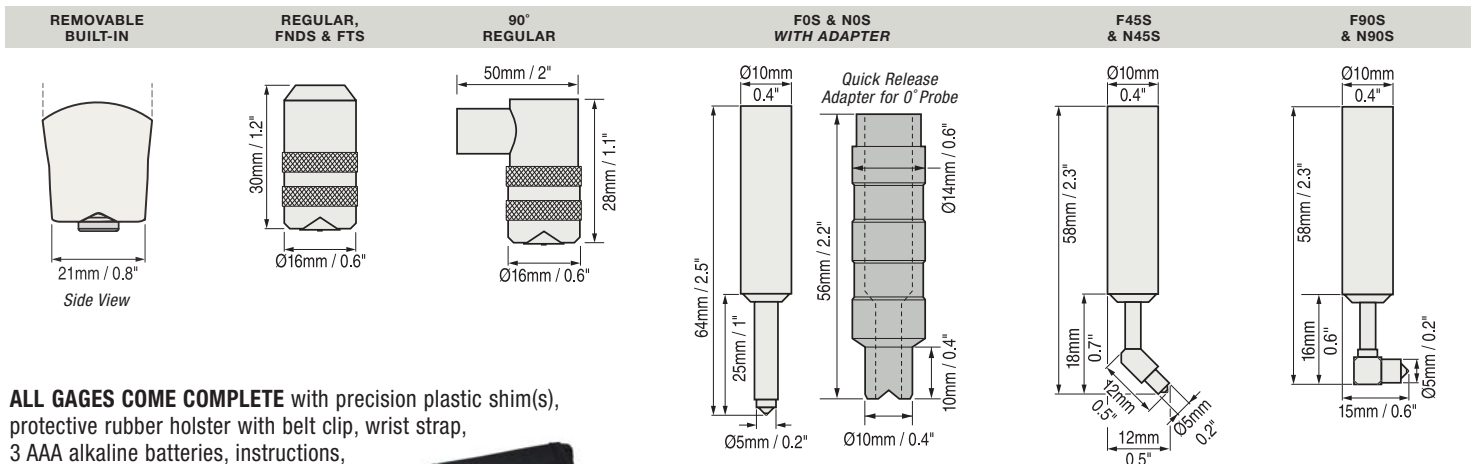

ALL GAGES COME COMPLETE with precision plastic shim(s), protective rubber holster with belt clip, wrist strap, 3 AAA alkaline batteries, instructions, protective lens shield, convenient carrying case, Long Form Certificate of Calibration traceable to NIST or PTB, USB cable, PosiSoft Software, two (2) year warranty.

SIZE: 137 x 61 x 28 mm
(5.4" x 2.4" x 1.1")

WEIGHT: 140 g (4.9 oz.)
without batteries

Conforms to ISO 2178/2360/2808,
ISO 19840, ASTM B499/D1186/
D1400/D7091/E376/G12, BS3900-C5,
SSPC-PA2 and others

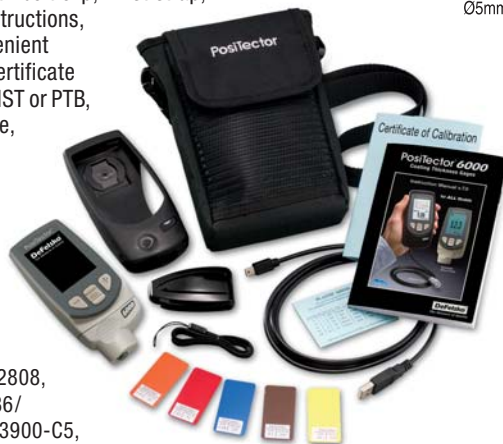

Options

Coating Thickness Standards to fulfill both ISO and in-house quality control requirements

Extended Cables for under-water or remote measuring. Specify length when ordering.



For a complete list of product features and available options visit www.defelsko.com

PosiSoft® Suite of Software

Four FREE and unique ways to view and report your PosiTector and PosiTest data

PosiSoft Desktop (v 4) — PC/Mac

Powerful desktop software for downloading, viewing, printing and storing measurement data. No internet connection required.

- Import readings directly from the gage via USB or from legacy PosiSoft desktop versions
- Export settings and templates for backup and sharing
- Report preview automatically refreshes as changes are made

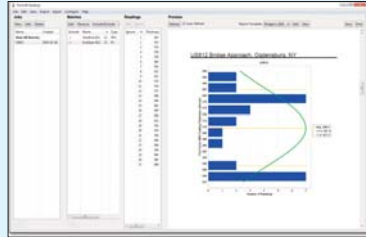

PosiSoft.net — Web-based

A web-based application offering secure centralized management of readings. Access your data from any web-connected device.

- Synchronize measurement data when connected via USB, Bluetooth or WiFi wireless technology
- Securely store measurement data in the cloud and share with authorized users via a secure login



Jobs Batches Readings

PosiTector App — Mobile

Mobile app connects PosiTector Advanced instruments, the PosiTector SmartLink and the PosiTest AT-A to your iOS or Android smart device.

- Auto pairing Bluetooth BLE connection
- Automatically generate user-formatted reports and share via email, text, cloud storage services like Dropbox, and more
- Export readings to PosiSoft Desktop or synchronize readings to and from PosiSoft.net for further reporting and archival options



PosiSoft Custom PDF Report Generator

Easily create reports from your measurement data in seconds.

featured on
PosiSoft Desktop
PosiSoft.net
PosiTector App

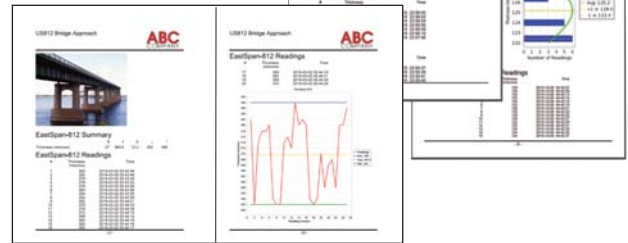

- Include inspection information such as on-site pictures, screen captures, notes and more to communicate important details
- Create and save multiple custom layouts as templates – insert cover pages, add logos/images, and select font and point size
- Select the information to include for each product type – charts, histograms, readings, time stamps and more
- Compile multi-batch reports from one or more probes and instrument types
- Export readings as comma separated value (.CSV) files which can easily be imported into Excel and other supporting applications

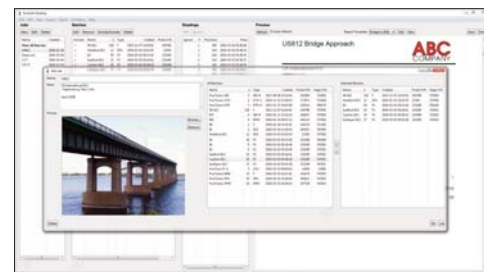

NEW Jobs feature consolidates batches into groups to keep measurement data organized and to quickly create multi-batch reports (not available on PosiTector App)

PosiSoft USB Drive — Gage Based

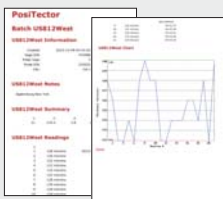

A simple gage interface to retrieve data in a manner similar to USB flash drives, cameras, or digital audio players. No software to install or internet connection required.

- View and print readings and graphs using universal PC/Mac web browsers and file explorers
- Measurement data can be printed quickly from a formatted HTML report or exported in .CSV format for further analysis in spreadsheets
- Simple file management - Copy and paste measurement data from the PosiTector to a local folder on your computer, network folder or cloud drive
- Access stored screen captures (snapshots) of the PosiTector display

DeFelsko®
The Measure of Quality

DeFelsko Corporation 800 Proctor Ave., Ogdensburg, New York 13669-2205 USA
Toll Free: 1-800-448-3835 • Tel: +1-315-393-4450 • Fax: +1-315-393-8471
techsale@defelsko.com • www.defelsko.com

Made in U.S.A.